



Reifenhäuser

CAST SHEET COATING

The Extrusioners

CAST SHEET AND COATING LINES

Value-Driven Solutioneering

**KNOW-HOW AND
TECHNOLOGIES
FOR FUTURE-PROOF
PLASTICS EXTRUSION
PRODUCTS**

If you produce plastic films, then you are probably facing many challenges at the same time: You need to manufacture cost-effectively in order to survive among the fierce competition. You must also impress your customers with reliable, high quality film, while at the same time meeting the constantly increasing demands on product sustainability. You can manage this balancing act by harnessing the right technologies.

VALUE-DRIVEN SOLUTIONEERING

Cost-effectiveness, quality, sustainability – combining all market requirements can be challenging. But with know-how and the right equipment, you will be able to make opportunities out of challenges and successfully develop your business. We can support you with our clever technologies, decades of experience and a fully equipped Technology Center. This will help improve your OEE (Overall Equipment Effectiveness), accelerate time-to-market, achieve a rapid ROI, reliably reproduce top quality, meet your verification obligations, develop new products and combine requirements

such as recyclability and use of recycles with economic efficiency.

To achieve this, we develop both standardized and customized cast film, sheet film and extrusion coating lines. We also offer individual components such as coextrusion adapters, cast components, polishing stacks and winders that are perfectly tailored to your requirements and give you decisive competitive advantages. What do you want to produce?

The Columns of “Value-Driven Solutioneering”

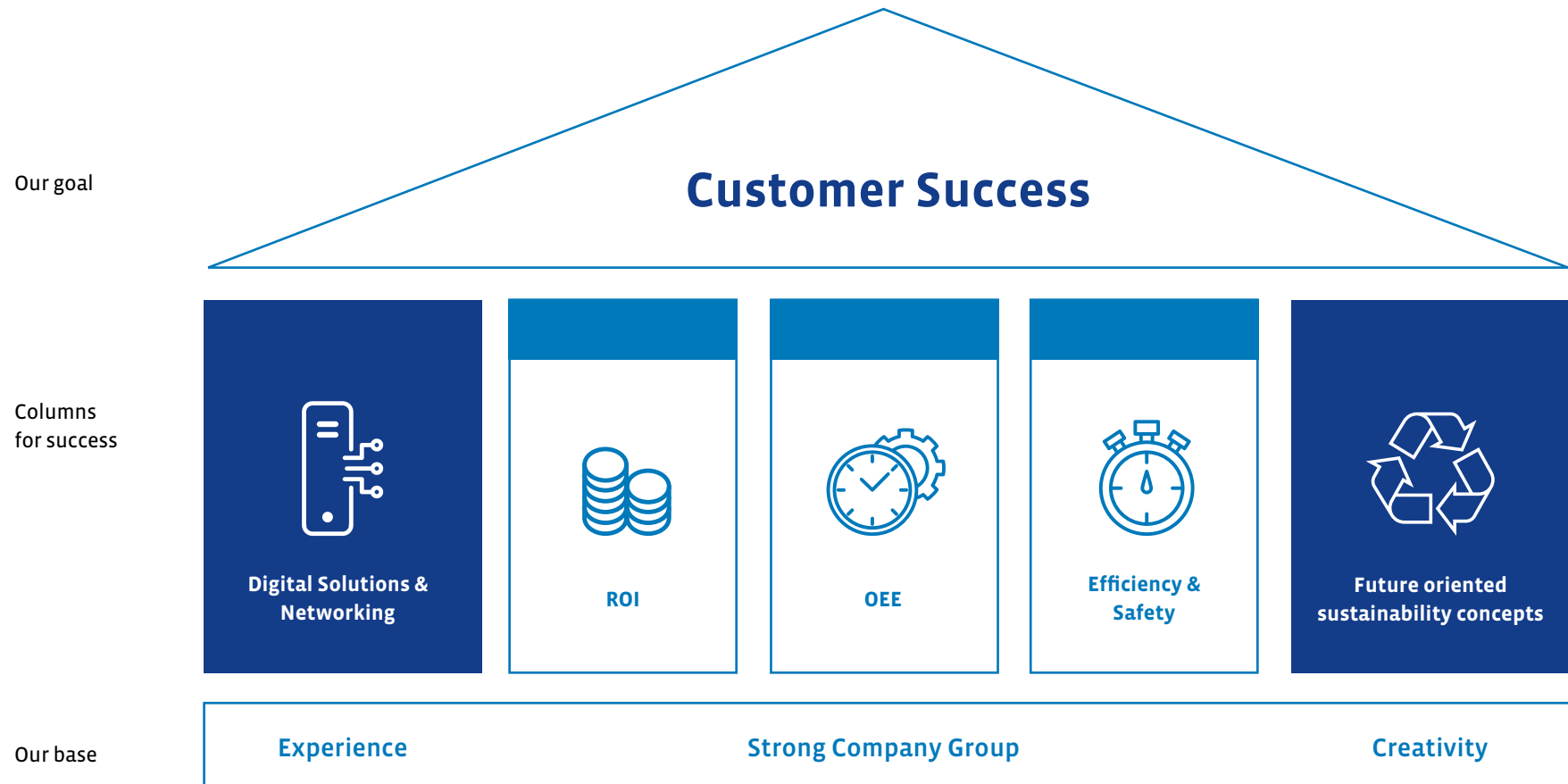

YOUR GUIDE THROUGH THIS BROCHURE

For easy and quick orientation, you will find different industry icons on the following overview pages, which identify Reifenhäuser's contents and solutions for industry-specific applications.



Consumer
Goods



Industry



Hygiene &
Medicine



Reifenhäuser

CAST SHEET COATING

CONTENTS

Applications

Consumer Goods	08 – 17
Industry	18 – 23
Hygiene & Medicine	24 – 27

Technology Highlights

Overview	28 – 31
PAM Dies	32 – 33
PAM Coextrusion Adapters	34 – 35
Facts	36 – 37

Service and Advice

Sustainability	38 – 41
Digitalization	42 – 45
Service	46 – 47
Research & Development	48 – 49
Contact	50 – 51



CONSUMER GOODS

The demands placed on packaging are higher than ever:

Packaging should optimally protect the contents with a reliable barrier, while being as recyclable as possible and – best of all – be made from recyclates. Since consumers make their in-store purchasing decisions within milliseconds, packaging must also be visually appealing. Reconciling all of these requirements and realizing them economically is one of the greatest challenges facing the modern packaging industry. Reifenhäuser lines support you in

successfully manufacturing for the consumer segment. They deliver consistent and reproducible film quality, minimized start-up and product changeover times, and opportunities for saving materials – by down-gauging, for example. This results in especially thin packaging films that are therefore more sustainable. Using Reifenhäuser plants you will be able to produce recyclable films and films with high recycled content without compromising product quality and barrier properties.

Today, even food packaging increasingly must be made from recycled material such as PET bottle flakes. Reifenhäuser technology that ensures processing of up to 100 % PET allows you to calmly master this market development.



A properly functioning circular economy requires packaging to be fully recyclable – a property that is impossible to fulfill with multilayer composites made from different raw materials. Packaging manufactured from monomaterials is a good alternative: They are fully recyclable, yet highly functional. Like these ALL-PE Pouches, in which BOPET or BOPP can be replaced with PE – thanks to cutting edge Reifenhäuser stretching technologies.





Scan the
QR code to
learn more.



Value Cast Lines **CPP**

Innovative Technologies for Consumer Goods

The commodity product CPP is in high demand from the packaging industry. It is highly transparent, weldable and can be easily printed or metallized. Its potential applications are many and varied. To help you succeed in this highly competitive market

with high efficiency (OEE), a fast return on investment for all these applications, and get your sales off to a flying start, we will configure your perfect system from a wide range of standard components.



Scan
to learn more

Narrow CPP Film Line

Mastering Smaller Jobs Flexibly and Economically

These lines are designed for lower outputs and are therefore ideally suited if you frequently change the product being made. The high level of component standardization favors rapid commissioning.

Typical Applications:

Bread bags, pasta packages, potato chip bags.



Scan
to learn more

Wide CPP Film Line

Mass Produce Products with High Productivity

These high-performance lines can be more than 7 meters wide and have an output of up to 3 tons per hour. They are ideally suited if you need to manufacture large quantities highly cost effectively.

Typical Applications:

Bread bags, pasta packages, potato chip bags.



Technology Highlights

- **Extrusion unit**
for economical processing of BOPP raw materials at full line capacity
- **Automated coextrusion adapter**
for rapid product changeovers and tightest tolerances
- **Automated die**
for rapid product changes that increase your OEE



Scan the
QR code to
learn more.



Value Lines

BARRIERS

Reproducible Quality for Optimum Shelf Life

Protecting food demands uncompromising quality and functionality. Your Reifenhäuser Value Line for barrier products gives you the flexibility needed to achieve the perfect layer structure. For us, 'perfect' means highly functional with the tightest tolerances. The technology also

supports you in reliably reproducing and documenting the quality of your film. This allows you to easily meet your statutory record keeping obligations vis-à-vis your customers.



Scan
to learn more

Cast Barrier

Manufacturing Flexible Packaging Films To Give Food a Longer Shelf Life

Value Cast lines for barrier products allow you to consistently achieve the exact combination of layers and raw materials that your application demands – and deliver convincing functionality. The raw material distribution is adjusted to the specific task – saving both time and material during ongoing production. Digital process and performance monitoring solutions ensure your film quality is always reproducible and traceable.

Typical Applications

High-quality packaging for perishable goods



Scan
to learn more

Sheet Barrier

Manufacture Thermoforming Film With Reliable Barrier Properties

Value Sheet lines for barrier applications are synonymous with films having the best optical and mechanical properties to guarantee consistent thermoforming quality. Thanks to a large number of possible layer combinations and the ability to adjust them during ongoing production, your line remains flexible and highly productive. Short changeover times and encapsulation also help you minimize production scrap.

Typical Applications

Aroma-sealed packaging for fish, cheese and coffee



Technology Highlights

- **Automated coextrusion adapter** for rapid product changeovers and tightest tolerances
- **Encapsulation in the coextrusion adapter** for waste reduction (sheet)
- **Die with automatic lip gap adjustment** for efficient material utilization
- **Mechatronic polishing stack** for easy reproducibility



Scan the
QR code to
learn more.



Value Lines

PET & PLA

Sustainable and Economical

The market is increasingly demanding food packaging made from recycled or bio-based raw materials. The Reifenhäuser PET and PLA Value Sheet lines – that have been established on the market for years – allow you to produce such

packaging in a particularly reliable, reproducible and cost-effective manner, while still retaining the flexibility to rapidly switch to new materials if required.



Scan
to learn more



Scan
to learn more

Sheet PET

Process 100 % Pet Bottle Flakes Directly Into Packaging Film

The Value Sheet lines for processing PET allow you to process up to 100 percent post-consumer recycle in a particularly energy-efficient and economical manner. Thanks to direct extrusion using a co-rotating twin-screw extruder, there is no need for upstream and energy-intensive crystallization and drying, which would otherwise be necessary. You benefit from easy product changeovers and a stable process.

Typical Applications

Blisters, trays, cups, display packaging

Sheet PLA

Manufacture Packaging Film from Bio-Based Raw Materials

Our Value Sheet lines are optimized for processing PLA, which means you can cost-effectively process the bio-based raw materials into packaging film without energy-intensive pre-drying. The line also allows you to process PET, giving you the flexibility to respond quickly to market demands.

Typical Applications

Blisters, trays, cups, display packaging

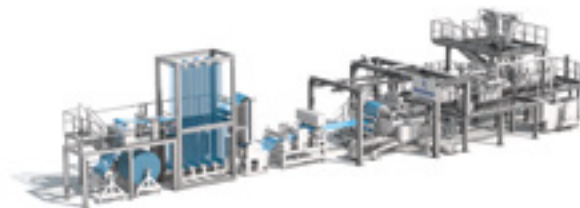



Scan the QR code to learn more.



Value Sheet Lines **PP & PS**

Our Value Sheet Lines for PP & PS allow you to produce one- to five-layer films with a high degree of transparency and stiffness, as required for dairy industry packaging, drinking cups and MAP packaging. To succeed in this particular commodity market, you need outstanding

overall efficiency effectiveness. Our lines contribute to this by giving you fast product changeovers and low energy consumption.



Scan
to learn more

Inline

Produce Bulk Goods Efficiently

The Value Sheet line for inline processing of PP and PS makes your production line particularly energy-efficient. The line is coupled inline with a thermoformer to ensure that the film is fed to the thermoforming process while still relatively hot, thanks to the short film transport distance. The high-speed extruder also ensures high output rates to improve overall equipment effectiveness (OEE) – another factor contributing to your success.

Typical Applications

Drinking cups, yoghurt cups



Scan
to learn more

Offline

Manufacture Roll Goods Efficiently

Our Value Sheet line lets you produce roll goods for you to resell for making end-use products. The line gives you the flexibility needed for frequent product changes and is designed for optimal OEE with a high-speed extruder.

Typical Applications

Drinking cups, yoghurt cups, meat trays



Technology Highlights

- **Automated die**
for rapid product changes that increase your OEE
- **Mechatronic polishing stack**
for reproducible settings to ensure consistent quality



| INDUSTRY

The highly diverse products made by the automotive, construction and solar industries are united by one development: there is an increasing demand for them to be sustainable. Industrial users are searching for recyclable products, materials made from recycle and ways to reduce their products' carbon footprints. Products that require less raw material and less energy to manufacture, or that can be produced using the cradle-to-cradle process, already have a clear advantage. Conventional products are therefore increasingly being substituted by more sustainable alternatives. Further developing these alternatives and making them economically

competitive is one of the greatest production challenges for industrial applications.

With the right technology, it is possible to increase the sustainability of industrial products and the way they are produced, while still keeping manufacturing costs low.

In cooperation with Reifenhäuser, you can also realize your own ideas of an ideal application. We will support you with technology developments that are tailored precisely to your requirements.

The automotive industry uses TPO films for high-quality vehicle interiors – for example, on the car dashboard.



Today, films are also used in products where one would not normally expect to find them. Solar panels and batteries are just two examples. Future-oriented industries depend on modern films and innovative technologies for their production lines.





Scan the
QR code to
learn more.



Value Lines

ROOFING UNDERLAYS

High Quality and Cost Effective

In the construction industry, lasting durability, climate resistance and high strength are important. The requirements placed on a film can vary greatly, even for the same application. Value lines for roofing underlays can therefore cover different needs.

Produce films and composites for breathable products, non-breathable products or moisture-resistant membrane applications.



Scan
to learn more

Construction Applications

Saving Costs with Direct Compounding

Value Cast lines enable you to produce breathable films for composite roofing membranes. The technology enables direct compounding, thereby drastically reducing raw material costs.

Typical Applications

Breathable membranes for roofing



Scan
to learn more

Roofing Membrane

Produce Adhesive-Free Composites

Our Value Coating line for roofing membranes allows you to produce film/nonwoven composites economically without the need for adhesives. We will tailor the line to your individual needs so you can meet the required product properties in the best possible way.

Typical Applications

Non-breathable membranes for roofing



Direct Compounding with Twin Screw Technology.

Co-rotating twin-screw extruders are unbeatable when it comes to compounding and direct extrusion. For example, the Value Ultra Twin extruders allow you to process 100 % PET recycling material without pre-drying, thereby significantly minimizing your energy and raw material costs.



Scan the
QR code to
learn more.



Value Lines **SHEET**

Customized Solutions for Special Applications

For some applications, even the most comprehensive modular system is not enough to configure a line that meets all production requirements. For example, where the application is subject to particularly stringent requirements in terms of

sustainable production. In this case, our Research and Development Center will work with you to develop a customized line concept that is tailored perfectly to your needs.



Scan
to learn more

Roofing Membranes

Produce an Alternative to Bitumen

Our Value Sheet line for roofing membranes allows you to produce a PO-based film for which market demand exists as an alternative to bitumen for flat roofs. The membranes are characterized by their consistent quality thanks to the tightest tolerances. This is facilitated by the mechatronic polishing stack.

Typical Applications

Waterproof membrane for flat roofs



Scan
to learn more

TPO Films

Convincing with Consistent Top Quality

Our Value Sheet lines for TPO films open up a wide production window within which to work. This is facilitated by the twin-screw technology, which hands you a high degree of flexibility when setting the process parameters. Reproducible parameters also deliver consistently high quality, which is critical in the automotive industry.

Typical Applications

Sheet for car dashboard



Successfully Entering Future Markets with Reifenhäuser

Growing markets such as the battery and solar power industries will need high-quality film products in future. Our decades of experience in specialist engineering and excellently equipped technical center allow us to readily support you in building up your expertise for successfully entering such new markets. Tell us what you want to produce.



HYGIENE & MEDICINE

Medical and hygiene applications are subject to strict regulations, and products must frequently be produced under sterile conditions in a clean room. Here, complete and well-documented quality assurance is crucial to product safety and in some cases is mandated by law.

While safety and functionality are absolute priorities in this market, the use of recyclate is inconceivable for producing some products. In the quest for more sustainable products, high material efficiency therefore plays a key role in medical and hygiene applications. Manufacturers that achieve the same functionalities with thinner films make an important contribution to

reducing the carbon footprint and, incidentally, are more cost-effective in production.

Reifenhäuser lines and components for medical and hygiene products therefore support you by delivering consistent, reproducible and documentable quality, so you can sleep peacefully at night. High productivity thanks to minimized start-up and product changeover times, coupled with attractive manufacturing costs thanks to the efficient use of materials, round off the overall package.

Medical products, such as IV bags, help doctors save lives. In no other industry is consistently high quality and reliable product sterility so important. Our proven technologies and clean room concepts ensure you will meet the demanding requirements.



Films perform the important function of a backsheet in such high-tech products as diapers. They stop liquids from passing through and are produced as films that are permeable or impermeable to air, depending on market requirements. Endeavoring to reduce material usage through downgauging is common to all variants. Our lines therefore fulfill this function, even at low film grammages.



The clean room concepts – developed by us specifically for medical applications – allow you to easily meet all of the requirements pertaining to hygiene.



Scan the
QR code to
learn more.



Value Lines

CAST & COATING

Solutions for Reliable Medical and Hygiene Products

Reifenhäuser lines allow you to produce medical and hygiene films to a level of quality and functionality on which your customers can rely 100%. Proven clean room concepts, together with technologies for ensuring reproducibility and producing documentation, give you the security and verification options you need as a producer in this market. The ability to manufacture

to the tightest tolerances along with clever solutions for saving materials through downgauging are further features to which you can look forward. This allows you to impress your market with high sustainability and cost-effectiveness in addition to delivering high quality products.



Scan to learn more

Barrier Films

Reacting Flexibly to Market Requirements

Value Cast lines for producing barrier films give you the flexibility you need to produce films with different properties for medical and hygiene applications. Short changeover times make switching between products commercially viable. Our clean room concept also means you can reliably meet the strictest hygiene requirements.

Typical Applications

Medical packaging



Scan to learn more

Ultrathin Coating

Film/Nonwoven Composites of the Lowest Grammage

Our Value Coating line allows you to produce especially thin nonwoven film composites using the Ultrathin Coating process without the need for adhesives. This process is more economical than alternative manufacturing methods and, thanks to downgaging, significantly improves the carbon footprint of disposable medical and hygiene products.

Typical Applications

Protective clothing, hygiene articles, surgical drapes

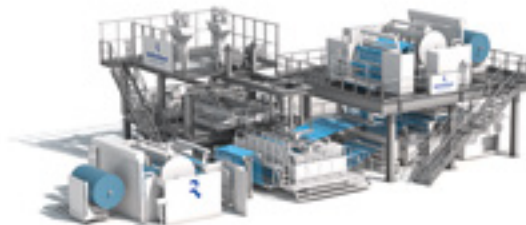

Downgaging with Ultrathin Coating Technology

This pioneering coating process allows you to produce particularly lightweight nonwoven film composites more cost-effectively and, therefore, more competitively than with conventional adhesive coating processes. A comparative analysis shows you will reduce your material utilization by 28% and manufacturing costs by up to 34%.



High Quality of Compounding, Mixing and Venting

Best in Class Hot Part

Extruder | Coextrusion Adapter | Die

In the extrusion process, it's the hot parts that count. With us, you therefore receive all components from a single source. They can be adapted flexibly to meet your requirements and are always perfectly matched to each other. Combine extruders,

coextrusion adapters, and dies with different equipment packages – for precision, automation and energy efficiency you will never want to do without again.

TECHNOLOGY HIGHLIGHTS

Scan to
watch the
animation



Value Twin Extruder

Cost-efficient production thanks to
compounding and PET processing.

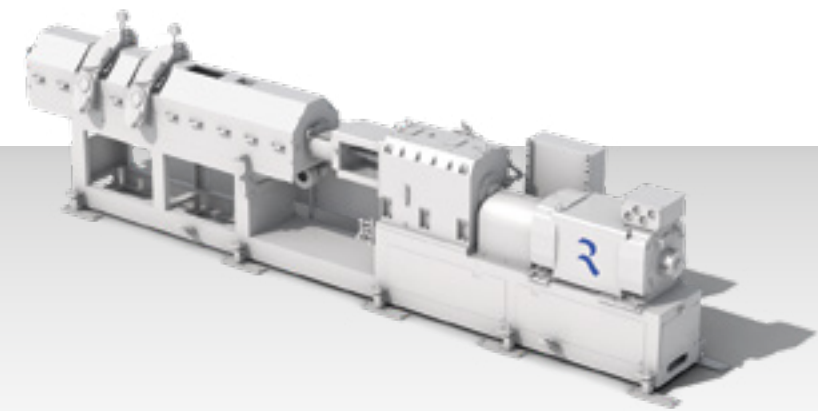



Settings can be made without line stop, without manual process and fully reproducible and trackable

Scan to watch the animation



PAM Coextrusion Adapters

Easily produce top film quality with minimal tolerances.

Scan to watch the animation



PAM Dies

Saving material and energy with digital technology.

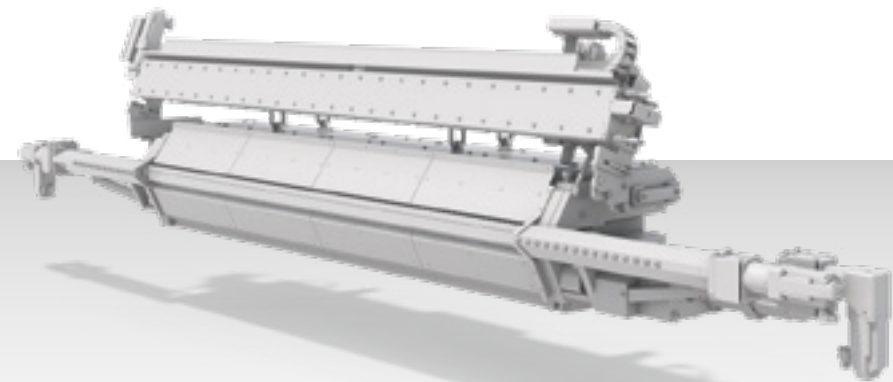
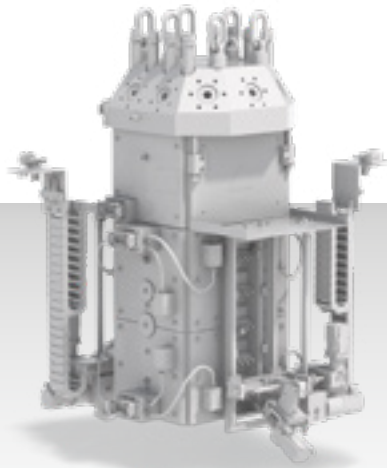

TECHNOLOGY HIGHLIGHTS

Value Polishing Stack

Saving material and energy with digital and mechatronic technology.





No Hydraulic Systems

Value Laminator

Mechatronics for highest precision of gap setting and gap pressure in market.

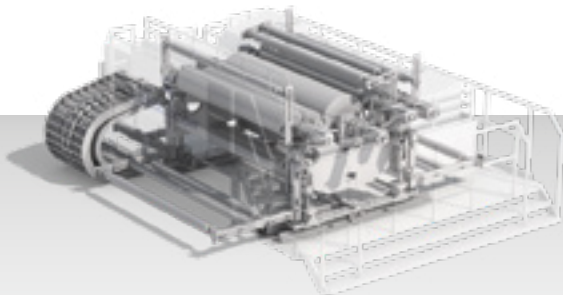

Value MDO

Improving film properties and lowering raw material costs.

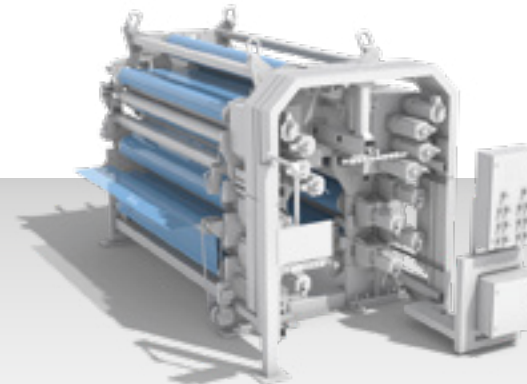

PAM CONVENIENCE YOU WILL NEVER WANT TO MISS AGAIN

Do you know those features that make you wonder how you ever got along without them once you get to know them? PAM has a good chance of becoming such a feature for you. That's because PAM makes your production life so much easier. No more wasting time and money. No more searching for the best setting. Never again put up with fluctuating quality. Never again feel guilty for producing unnecessary waste. No more frustration over long product changeover times. No more worrying about high energy costs. As you can see, PAM is a convenience that also pays off for you economically.

Convenience Features That Pay Off



Automatic product changeovers ensure reproducible quality, making you a sought-after supplier.

PAM Dies

The mechatronic, reproducible die adjustment minimizes your product changeover times so that you improve your OEE.

Automatic die settings reduce waste, so you produce more sustainably and save on material costs.

Operation without thermal expansion bolts reduces your energy consumption, so you can face rising energy costs with peace of mind.

Operatorless adjustments reduce user errors, so that line availability and work safety increase.

PRECISE. AUTONOMOUS. MECHATRONIC.



PAM pays off in energy savings alone

PAM enables autonomous adjustment and control of the flex lip and thus of the thickness profile. In addition, depending on the version, autonomous adjustment of the restrictor bar, width adjustment, and lip opening can be achieved by adjusting the lower die lip.



Scan
to watch
the animation

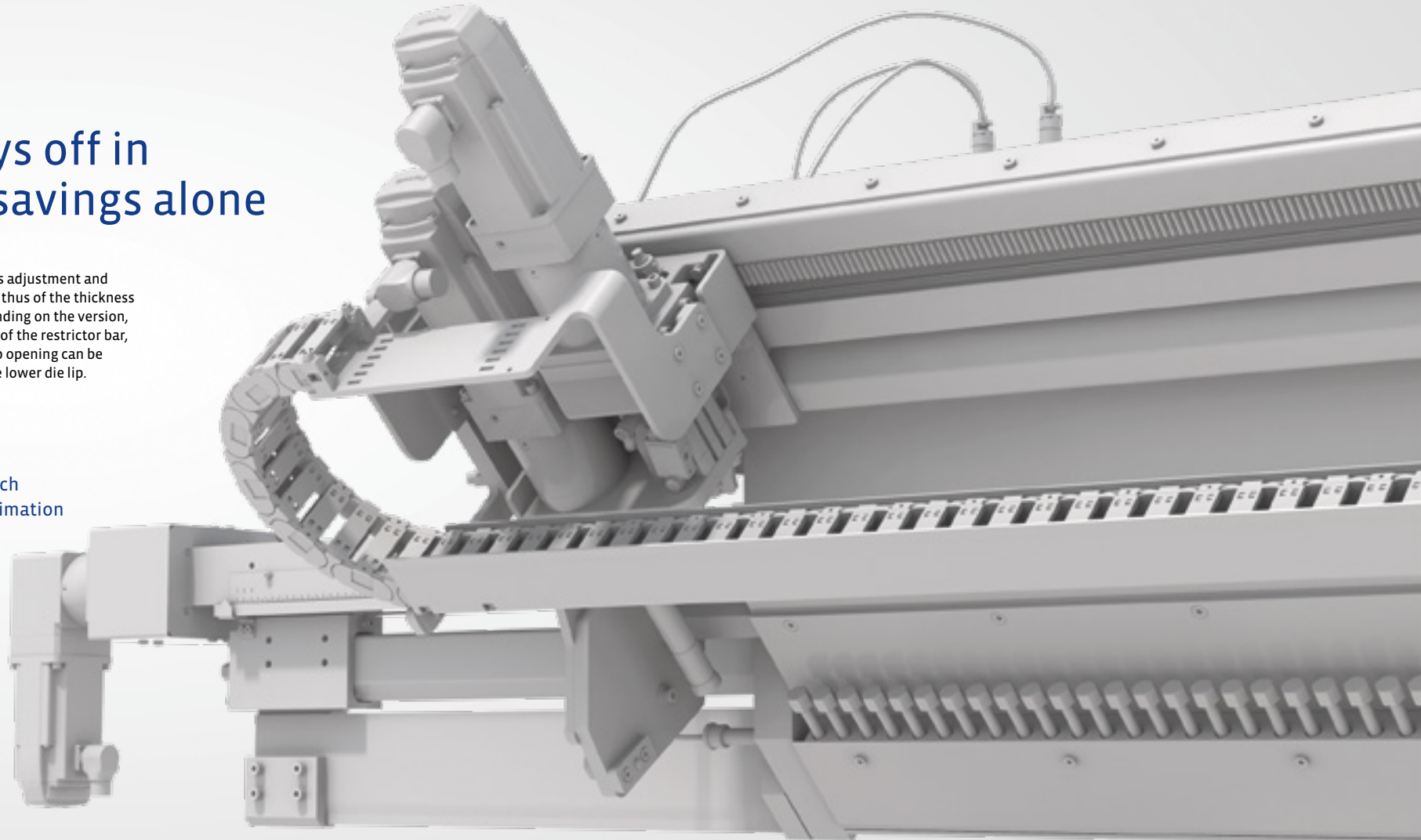

PRECISE. AUTONOMOUS. MECHATRONIC.

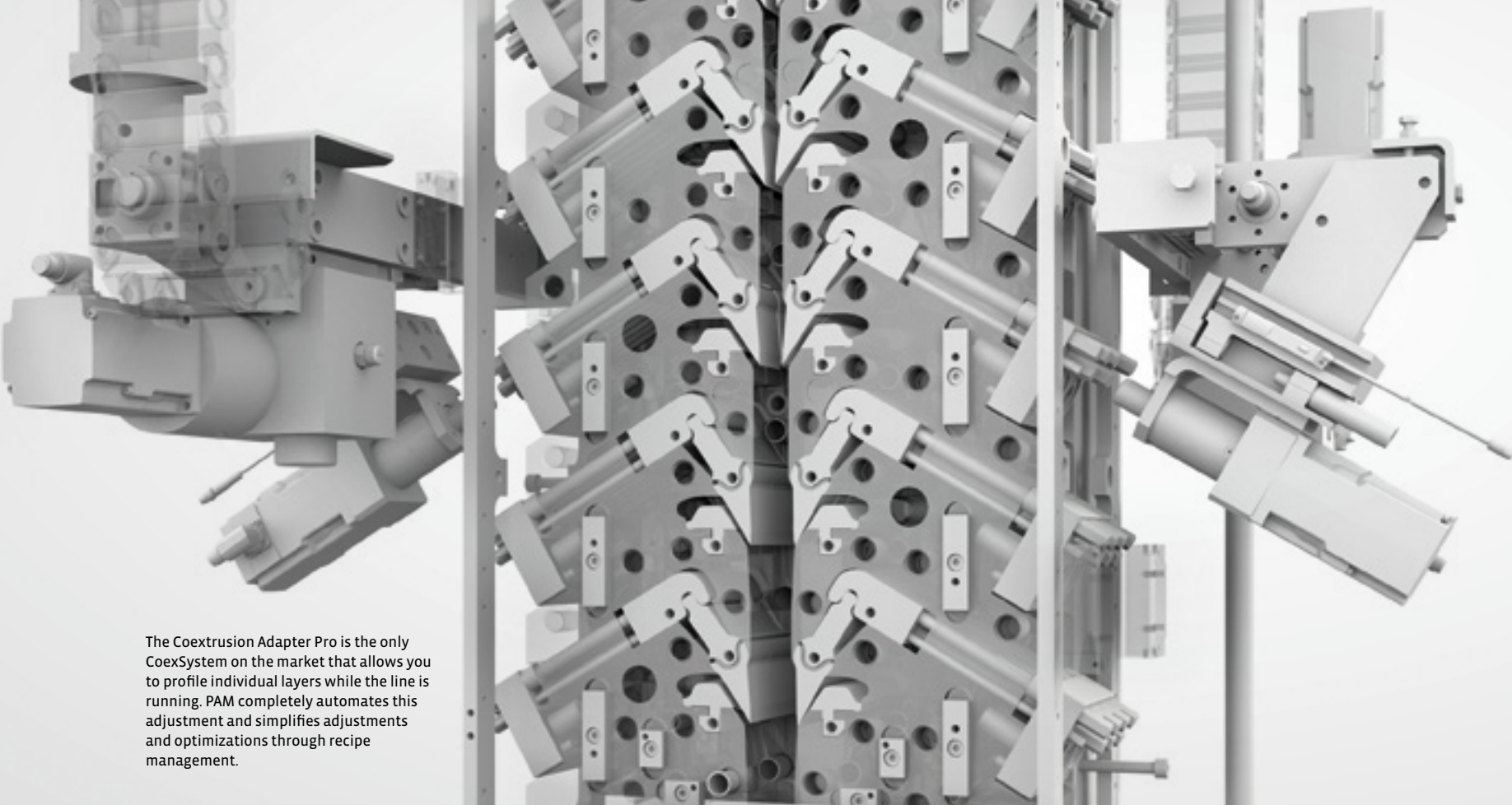

The Coextrusion Adapter Pro is the only CoexSystem on the market that allows you to profile individual layers while the line is running. PAM completely automates this adjustment and simplifies adjustments and optimizations through recipe management.



Scan
to watch
the animation

PAM Coextrusion Adapters

Convenient Features That Pay Off

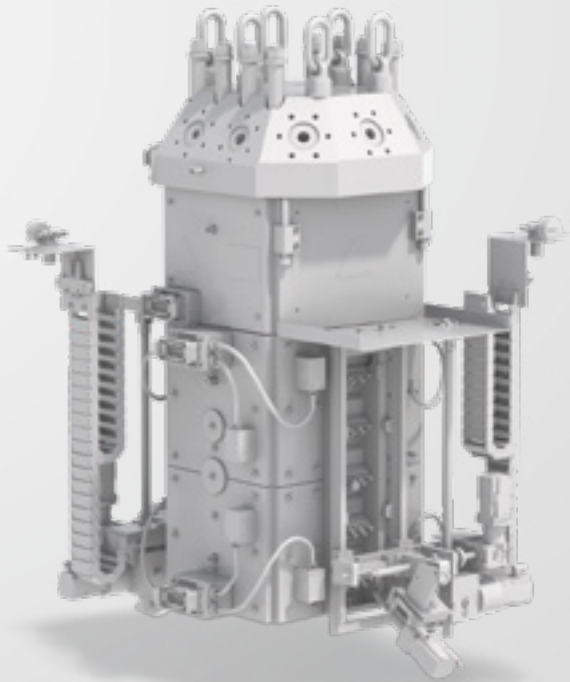

Recipe memory for quick adjustment while the line is running. This increases your good production and makes you less dependent on the qualifications of individual line operators.

Contactless adjustment while the system is running. This offers operators a higher level of work safety.

Optimized layer distribution for reduced scrap and material usage, to increase your margin.

Automatic profiler control to minimize setup and changeover times, and that improve your efficiency.

Digital fingerprint for traceability of setting parameters to make it easier for you to provide documentary proof to your customers.

PAM

PRECISE. AUTONOMOUS. MECHATRONIC

Higher Productivity

+180
t/a

With the PAM option, you produce significantly more barrier film per year because you can adjust both the die and the coex system on the fly.

-70%
Savings

Save the investment for a new die. We refurbish any type of flat die – regardless of the manufacturer.

Best Hot Part

With perfectly matched components from extruder to die, we deliver the best hot part on the market.



We understand the overall process because we benefit from the know-how of the large network within the Reifenhäuser Group.



1,750

EMPLOYEES 2022

78%

**Faster
With PAM**

when changing the width of a cast application with internal width adjustment.



**We Manufacture
All Core
Components
In-House.**

130,510

kwh/a* Energy Savings

By switching from thermal expansion bolt technology to PAM, you protect the environment and save money.

*Example based on a 3000mm wide cast film die.





R-Cycle

MAKE YOUR PRODUCTS IDENTIFIABLE FOR RECYCLING

Give your product a digital identity with readable, recycling-related information so that it can be properly sorted and recycled at the end of its life – for the benefit of a functioning circular economy and the recovery of high-quality recyclates. The cross-company R-Cycle initiative launched by Reifenhäuser provides an open, globally applicable traceability standard for this purpose.



Scan to
learn more

We have only one planet. Therefore it is our task to preserve the livelihoods of future generations.

SUSTAINABILITY

In the plastics industry, we have focused for too long on product functionality and placed too little emphasis on their sustainability. Yet plastics possess all the prerequisites for establishing a circular economy and reducing our carbon footprint. A potential that should benefit the environment and your economic success. We therefore provide you with technical solutions and proven end-use applications that will equip you for current and future requirements.

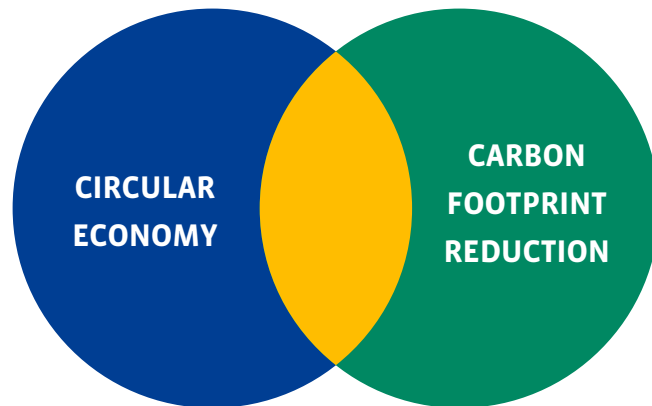

We offer technologies that help you contribute to the circular economy and reduce your product carbon footprint.

Combining sustainability and profitability: Learn about your fields of activity and specific solutions.



Manufacture recyclable products



Manufacture products from recycle



Achieve material savings (downgauging)



Process bio-based raw materials



Reduce scrap

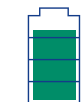

Save energy



PET Recycling

FOOD-SAFE SHEET MADE FROM RECYCLATE



“The market for recyclable food packaging made of PET is already a high-volume one. At the same time, the growth potentials are equally interesting considering the current global collection rates. We are now making it easier for customers to successfully participate in this market.”

Mark Schuster, Product Manager PET Sheet at Reifenhäuser Cast Sheet Coating

A certified process from Reifenhäuser Cast Sheet Coating allows the production of food-safe sheet from recycled PCR-PET material - without the need for sheet producers to invest in an upstream cleaning and drying process.

If recycled material comes into direct contact with food, it requires special certification from the European Food and Safety Authority (EFSA). Reifenhäuser Cast Sheet Coating has developed a solution for the production of recycled PET sheet using a twin-screw extruder and a high-performance vacuum system that meets stringent EFSA requirements.

The benefit: The certified process directly processes PET recycling material without pretreatment or predrying in an additional reactor – which is otherwise required with other processes. Sheet producers save their investment in an additional equipment and avoid additional energy and maintenance costs.

Flexible PET Recycling

The new Reifenhäuser process produces food-safe sheet from up to 100% PET bottle flakes. It also permits quick material and product changes, for example from post-consumer PET bottle regrind (PCR) to post-industrial PET production waste (PIR) or to virgin PET.

The packaging end product, such as a meat tray, then meets extremely high standards and is safe for use in packaging that comes into direct contact with food.



[Read the whole story here and get to know the 4 steps to food-safe film from 100% recyclate.](#)



[Scan to watch the video](#)



For EFSA audits, recipe- and product-related data of the certified process must be stored for several years. The ExtrusionOS Production Compliance software bundle helps to monitor and securely document production processes and compliance with EFSA-relevant thresholds in a data-based and real-time manner.



MACHINE HEALTH

Detect, store and historically trace the condition of all connected assets and to optimally set them up based on the gained insights, so you can optimize your processes along the entire production chain.

PRODUCTION COMPLIANCE

Monitor and document your production processes data-based to prove compliance with key thresholds. This enables you to act fast and significantly reduce errors and customer complaints.

DEFECT ANALYTICS

Gain transparency on defects that occurred – for each roll produced. Monitor all your defect specific KPIs at all times, so you can trace and analyze your defect occurrence efficiently and reduce scrap.

DIGITALIZATION



Scan to learn more about digitalization with Reifenhäuser.

Would you agree that all film manufacturers – regardless of size – should benefit from the enormous potential of digitalization without becoming dependent on specialists, specific systems or manufacturers? We have therefore created an ecosystem that allows you to link all pieces of your production equipment, regardless of the manufacturer. The aim is to create a universally valid and correct database that will help you increase the efficiency of your entire production – easily, safely and independently.

We will support you with:

c.Hub

Core platform that allows you to digitally connect your shopfloor, as well as monitor, manage, store, and analyze your process data with intuitive and user-friendly applications and dashboards. Also included: Out-of-the-box connectors for the major industry protocols, that allow for easy integration of Reifenhäuser machinery via “plug & play”.

ExtrusionOS Suite

Our digital products help you to solve the most common challenges in film production with a wide range of different features. These enable you to sustainably increase the quality, performance and availability of your production. A new dimension of transparency of your data will support you in troubleshooting and makes your data secure and easy to track.

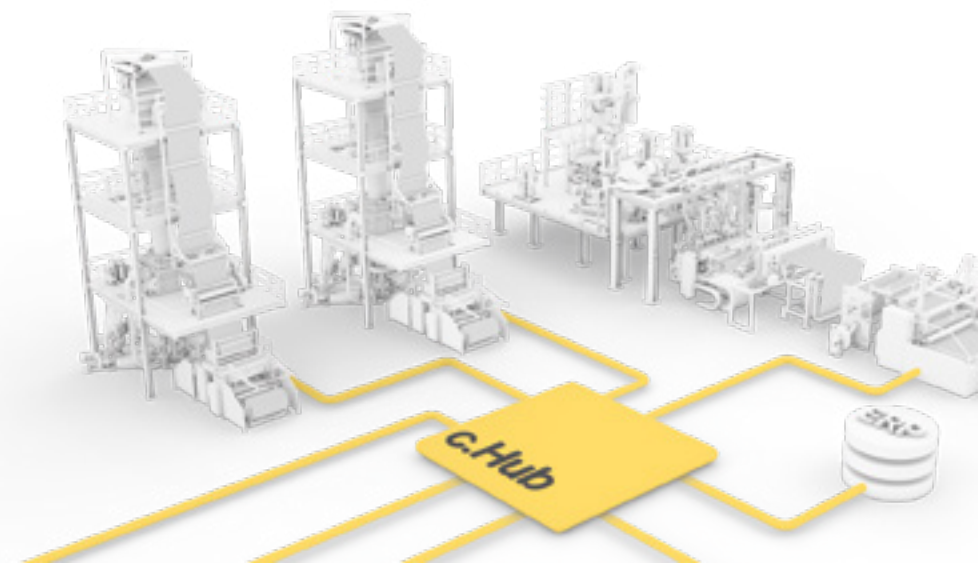

Interview

“DIGITALIZATION IS A JOURNEY, NOT A DESTINATION”

Daniel Kajan, Director Product & Operation, RE: GmbH

Do producers of films and nonwovens really know whether their production is running at optimum efficiency? Many could be more productive if they leveraged the enormous potential offered by digitalization to the full extent. Reifenhäuser has therefore launched a digital campaign with its corporate start-up RE:.

A discussion about the concept and the added value in practice between Daniel Kajan, Director Product & Operations at RE:, Mark Schuster, PET Product Manager at Reifenhäuser Cast Sheet Coating GmbH, and Eugen Friedel, Vice President Sales and Marketing of the Reifenhäuser Group.





“At Reifenhäuser, we offer expertise in mechanical engineering, extrusion technology, and software development from a single source.”

Eugen Friedel, Vice President Sales and Marketing, Reifenhäuser Group

Reifenhäuser intends to provide plastics extrusion companies all over the world with an easy entry into digitalization from which they can profit sustainably – regardless of company size. Reifenhäuser bases its solution on a cross-manufacturer approach that is the first to connect all installed lines and machines in a production facility.

Mr. Kajan, what is RE: and what support does it provide producers of film and nonwovens?

Kajan: We develop digital products that enable producers of films and nonwovens to optimize their assets based on data and thus increase production efficiency. Here, we not only integrate lines manufactured by Reifenhäuser but also those of other vendors as well as all additional equipment used along the way to the end product.

RE: works closely with Reifenhäuser business units. What added value does digitalization bring, specifically to film and nonwovens production?

Kajan: The potential of data is greater than ever before! Companies with access to all production data can quickly make processes more efficient and boost the quality of

their products – a huge competitive advantage.

Friedel: Actually, the calculation is very simple. Every producer knows the price per kilo of his raw materials and how many tons of material pass through his production line every year. And he knows the power consumption of his line and the cost of each kilowatt hour. If he only increases his OEE by one percent using our digital solution, he already saves several thousand euros a year.

Schuster: Data acquisition and documentation is also essential for proof of compliance, for example, for medical products or food packaging.

If, for example, a food company complains that a product packaged in film is spoiling prematurely, it is a great advantage if the film producer can seamlessly document from the first to the last meter that he has

complied with all agreed quality parameters during production. With our solution, the roll can be virtually taken apart. Customers are able to inspect the production parameters as well as quality KPIs down to the meter.

That sounds convincing. Why do some plastics converters still shy away from taking the first step?

Kajan: Because the market for digital applications is extremely diverse. Many producers find it difficult to pick out what they really need from the sheer mass of options. In a survey of our customers, 31% stated that they needed help in making their choice.



Scan to read the full story online

ALWAYS AT YOUR SIDE

Our technical support takes care of all urgent issues relating to your production plant – on site or particularly quickly via remote access for immediate support. Whether remote maintenance, visual assistance or smart assistance systems: we focus on digitalization in service.



SERVICE

You use outstanding equipment to build the foundation for successful, cost-effective production. You build on this foundation by delivering good service. We have therefore established a comprehensive service offering for you. It guarantees fast help when you need it, keeps your equipment running efficiently for decades, ensures you're fit for new challenges, and gives your employees the best possible qualifications – allowing you to successfully and highly productively continue producing flat films into the future.



Get to know
our service
products

YOU BENEFIT FROM:



Technical Support
for fast help when you need it



After Sales Service
to ensure line availability that
contributes to your success



Original Spare Parts
for quality that enhances the
performance of your line



Research & Development
for support that secures your
future



AR:DEL Academy
for employees who become
boosters of your productivity.

FACTS RESEARCH AND DEVELOPMENT

- ✓ **Modernized**
2017 – 2019
- ✓ **Equipment**
Up to 10 high-tech lines with the latest line generation for the production of blown film, cast film, sheets, and nonwovens
- ✓ Meeting and training rooms
- ✓ 2 laboratories
- ✓ **Total area**
About 5,000 square meters
- ✓ **IoT**
Connection of all lines



Scan to
learn more



RESEARCH & DEVELOPMENT

You're probably also aware of the following dilemma: You are developing future products but face the choice of blocking production capacities to do so, or continuing to process orders that generate revenue? As a Reifenhäuser customer, you no longer have to decide between current business and preparing for future success. You will have access to our state-of-the-art Research and Development Center which houses high-tech facilities and testing laboratories. Our team of experts will be pleased to support you on request. They will ensure successful test planning, test execution and evaluation, to ensure you can design your future in peace without interrupting your in-house production.

How you benefit:

- Undertake research while you continue to earn money
- Learn about state-of-the-art technology and discover your potential
- Transfer the results directly to your production for a fast return on investment
- Gain knowledge thanks to state-of-the-art laboratory measurement equipment
- Obtain support for test planning, execution and evaluation for less stressful development of your future business
- Make the most of the Reifenhäuser experts' advice and save yourself time
- Start exclusive development cooperations and stand out from the crowd.

Visit Our Virtual Technology Center



Scan to
make an
appointment

LET'S TALK ABOUT YOUR GOALS!

We look forward
to receiving your
inquiry.

T +49 2241 481-0
sales@reifenhauser.com

Follow us!





Reifenhäuser Cast Sheet Coating GmbH

Spicher Strasse 46

53844 Troisdorf, Germany

T +49 2241 481-0

info@reifenhauser.com

www.reifenhauser.com